

AUTOMATED CAR WASH WITH PARKING SYSTEM



Presented By:
Ibrahim Ashour
Bahaa Abbas



Supervised by:
Dr.Suleiman Abu
Kharmeh

CONTENTS

1. Introduction.
2. Primary Goals.
3. Car Wash & Park.
4. Work Chart.
5. Hardware Parts.
6. CHALLENGING & CONSTRAINTS
7. Future Work.
8. Conclusion.



AUTO WASH

YOUR TAGLINE GOES HERE

INTRODUCTION

The Automated Car Wash with Parking System project represents an evolution from conventional car wash approaches, offering a hassle-free solution for getting your car cleaned and parked. Utilizing smart technology such as sensors, it automatically washes your car and efficiently manages parking needs. It's all about making car care and parking easier for everyone.



Automated Car Wash with Parking System



PRIMARY GOALS

Time Saving

Convenience

Efficient Cleaning

Increases Productivity

Mobile Controlling

CAR WASH & PARK



WORK CHART

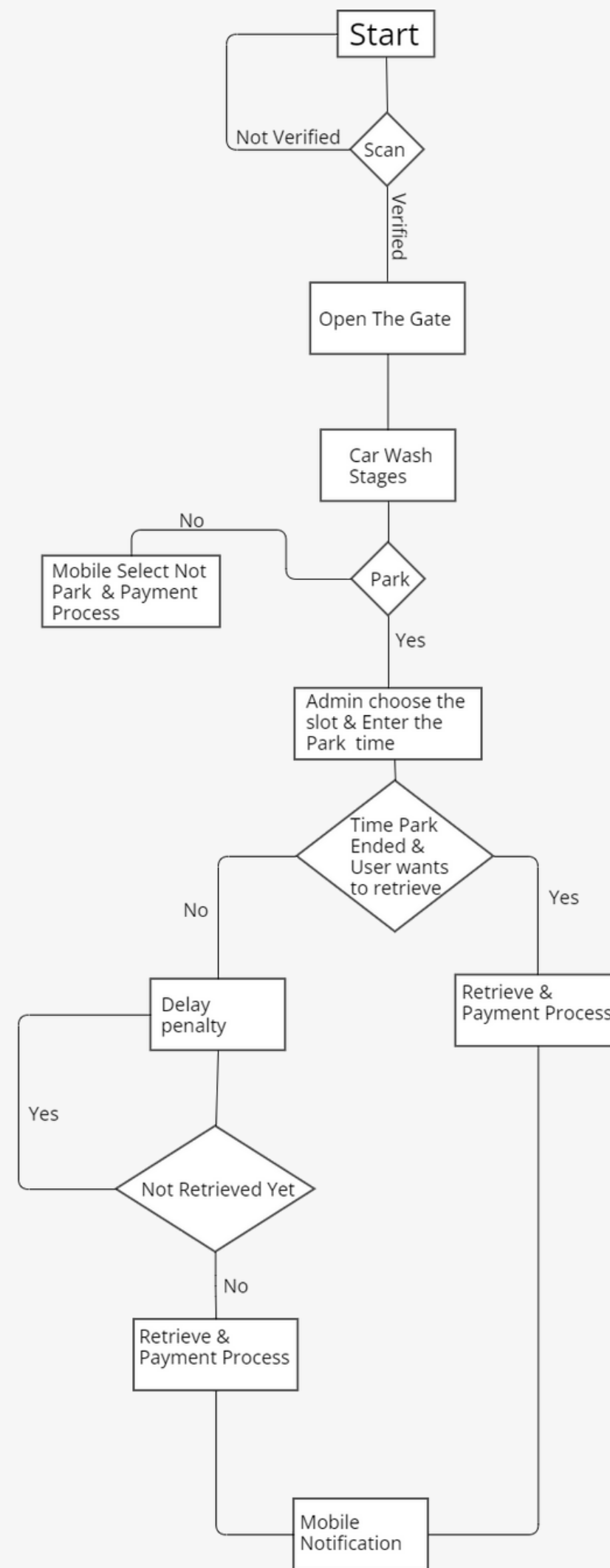

HC-05 MODULE TO CONTROL THE PARK PHASE.

01 Status for every park slot.

02 Controlling when to park or to retrieve.

03 Displaying the timer for parking slots.

04 Displaying the payment cash.

05 Various notifications for admin.

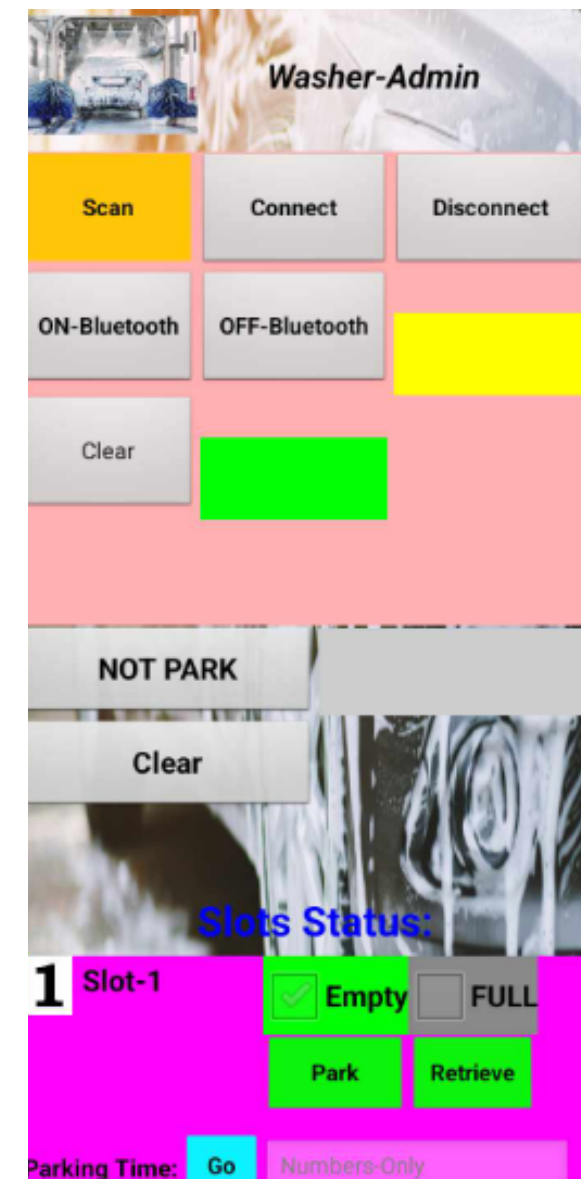
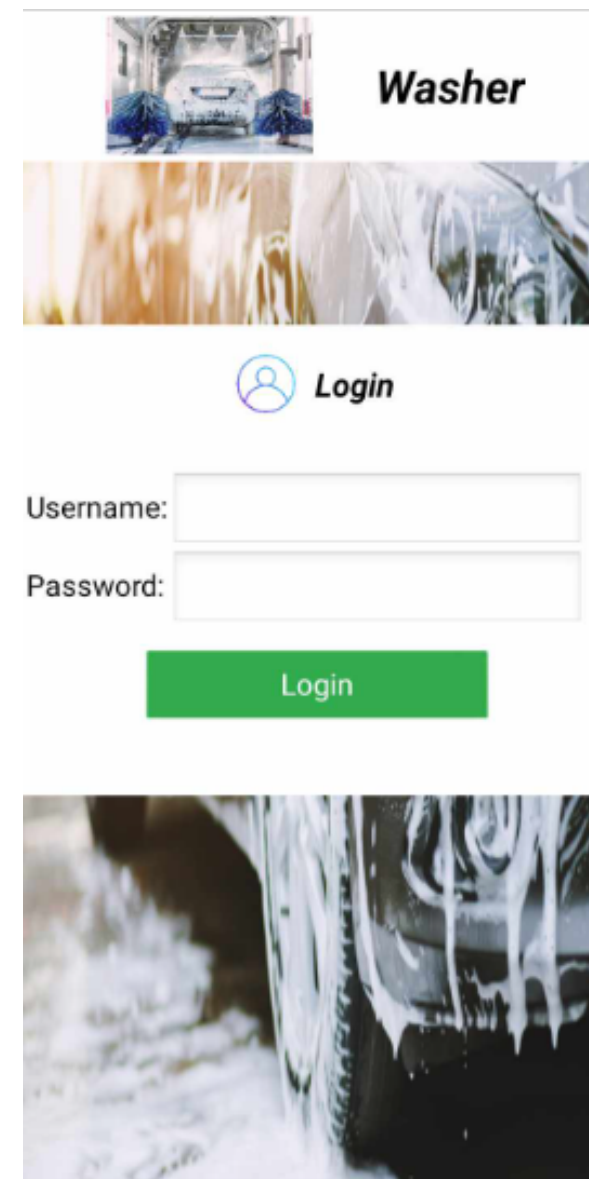

HARDWARE PARTS

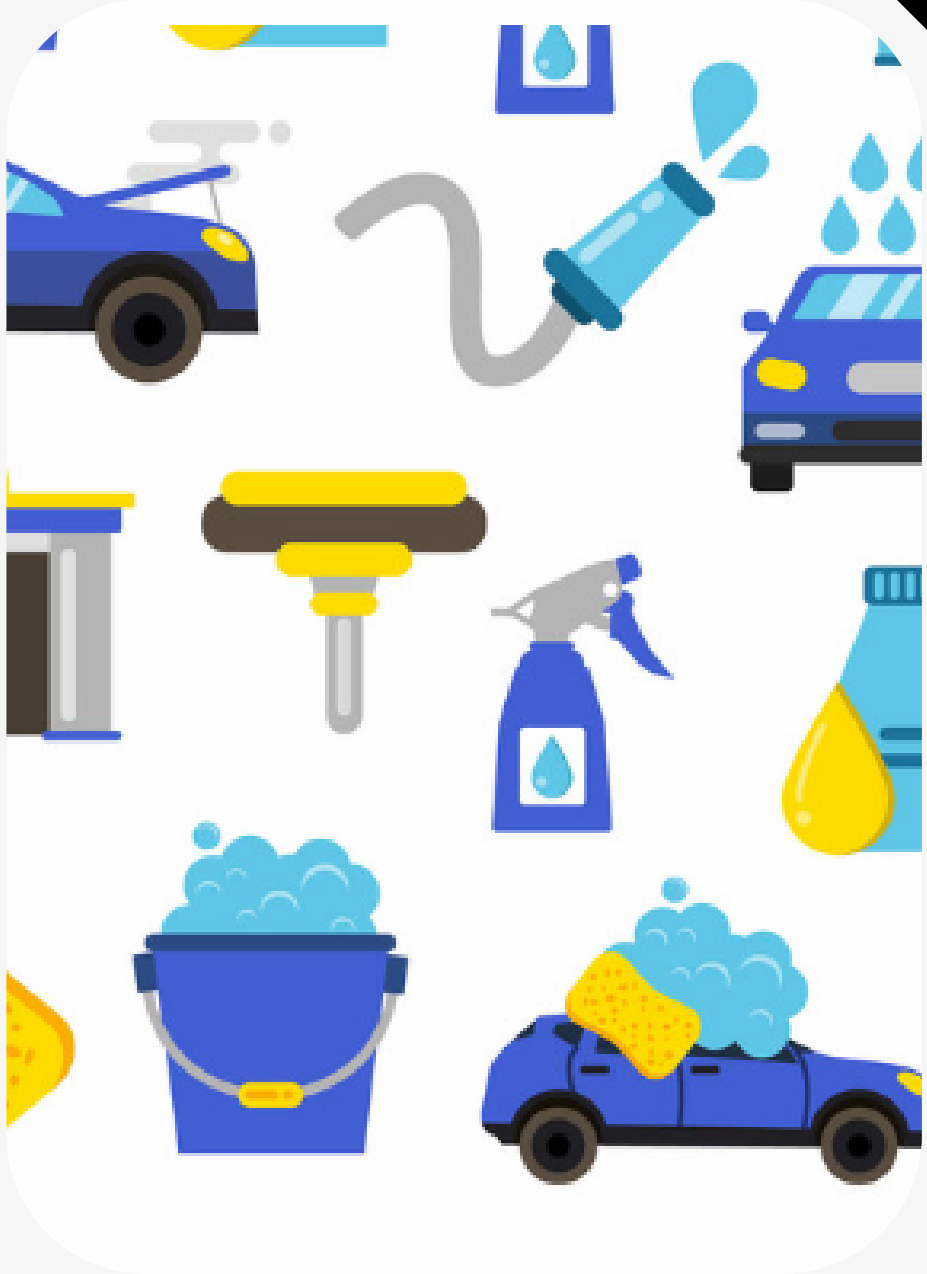

ARDUINO MEGA

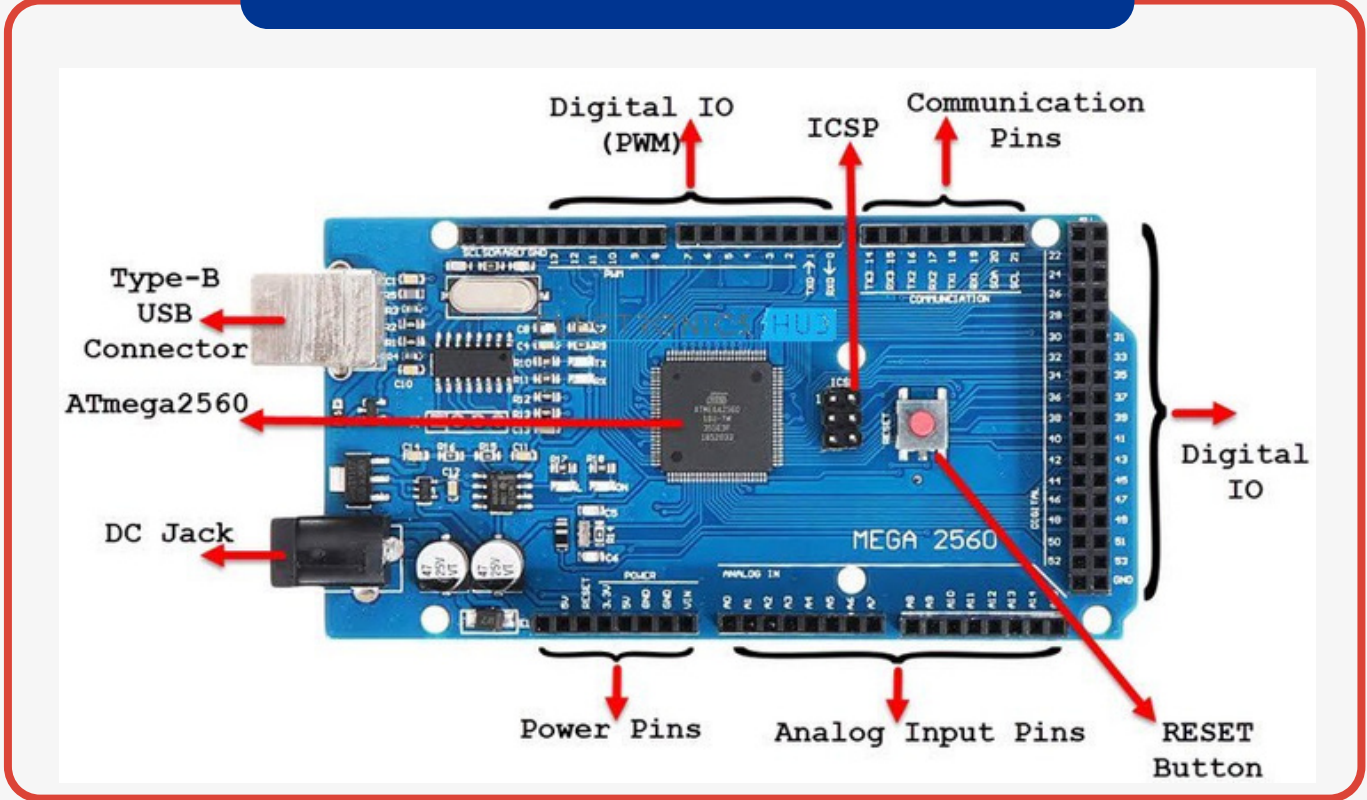

ARDUINO Uno



Conveyor Belt



DC Motor



Dc Motor



Servo Motor



HBridge

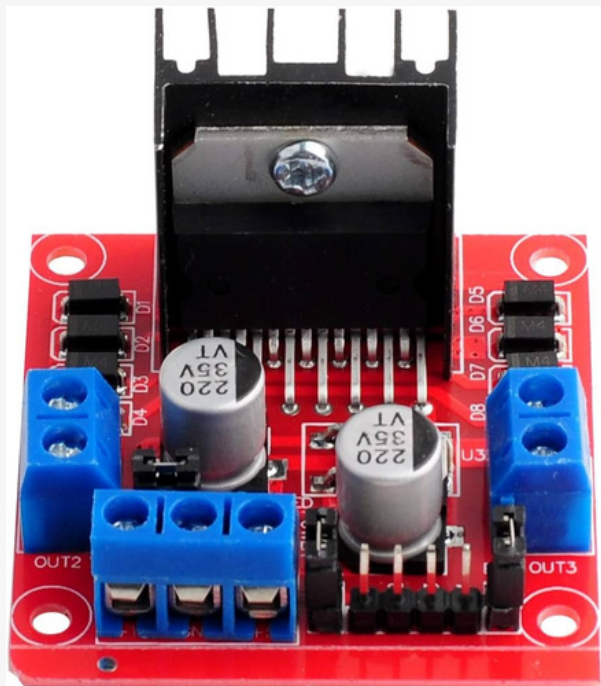

Limit Switch



Stepper Motor



A4988

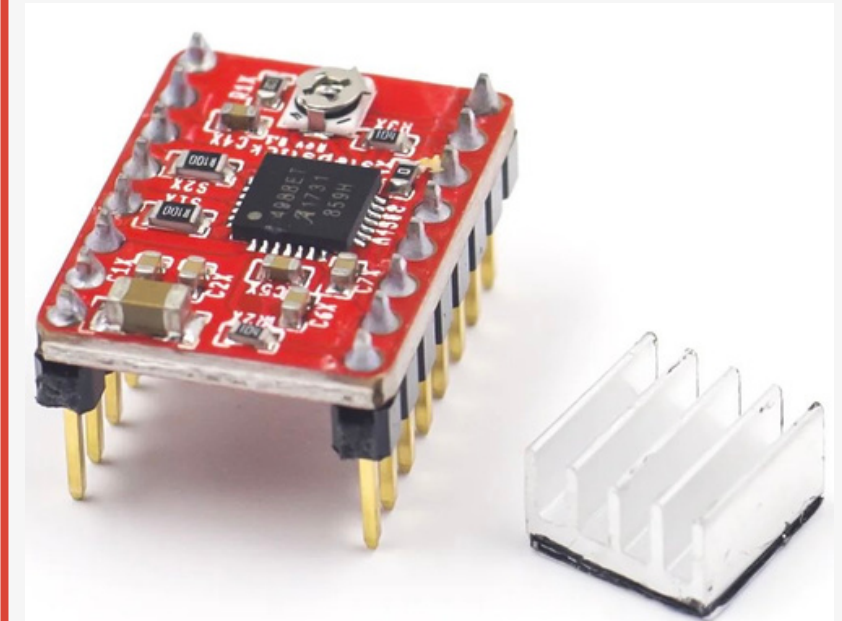

Water Pump



Ultrasonic Sensor



4-Relay Module

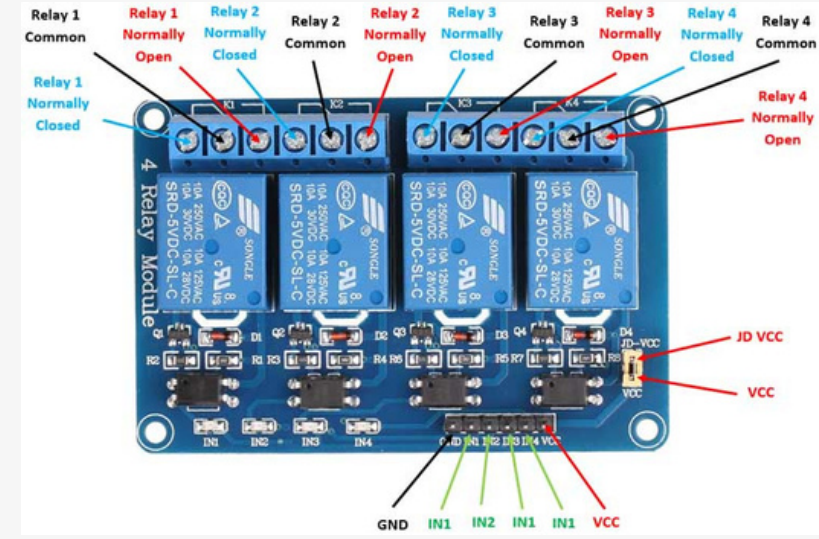

Bluetooth Module

HC-05 FC-114

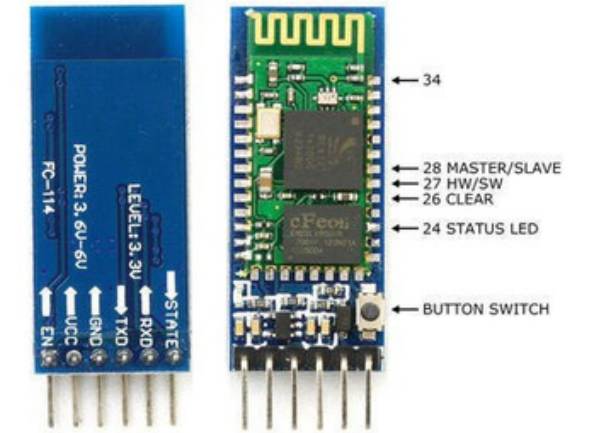

LCD

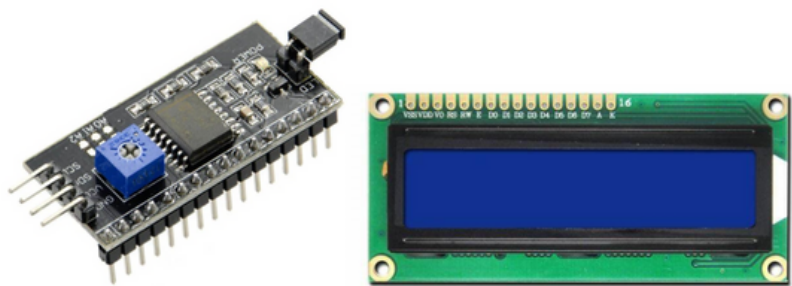

Fan



Timing Pulley



Gantry Plate 4-Wheels

GANTRY PLATE WITH WHEELS



Corner Brackets

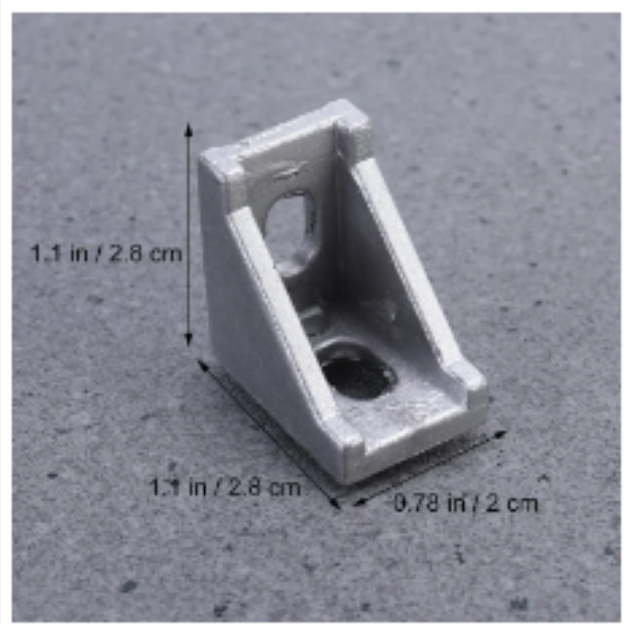

openbuilds wheel



Nuts



T-Slot Nut



Saiper Timing Belt



Socket Cap



V-Slot



Timing Belt



Brushes



Bread Board

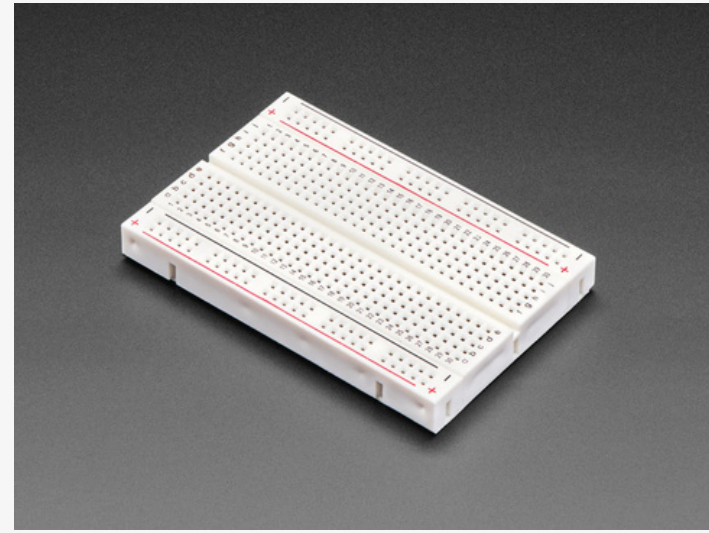

Water Pump Hose



RFID Card



Power Supply



wires



CHALLENGING & CONSTRAINTS



1

Dealing with small electrical parts was difficult, like drivers.

2

The CNC balance was a bit of a headache due to the overall weight.

3

Considering all the situations we are going through, what makes it harder is that both of us are from different cities, and communication was difficult and risky.

FUTURE WORK :



- Image Processing :
Instead of using the sensors to detect the car movement and which stage it reached , using image processing will provide more accurate detection and provide more feature to implement.



- Water Recycle :
Recycling the waste water to use it back again or benefit from it in another aspect such as crop irrigation.

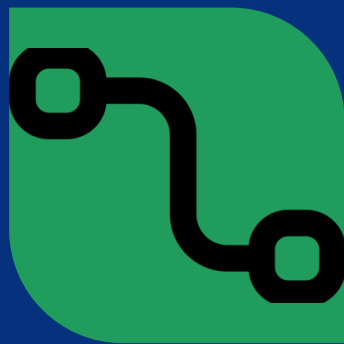

- Pipeline Car Wash :
Instead of wash only one car in the time , and reserve the whole system for it ,we can wash several cars simultaneously , where every car in different stage.



CONCLUSION:

In conclusion, the project has succeeded in achieving all of the outlined goals for implementing the automated car wash with parking.

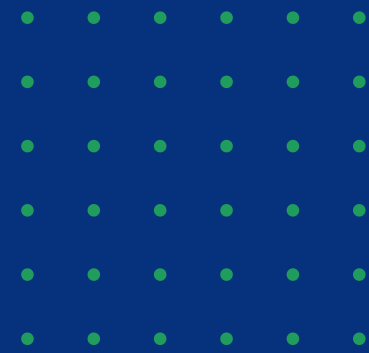

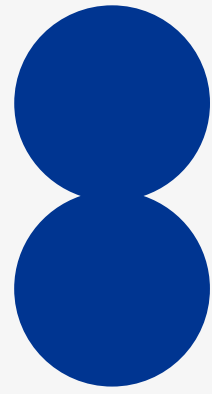

**ANY
QUESTIONS?**

