

Mojito Machine

Made with love by

- Jamal SaadEddin
- Omar Qaneer

Under supervision of

- Dr. Haya Samaaneh





Agenda

Introduction

Equipment's

Project Functionality

Constraints

Future Work



Introduction

Our innovative Mojito Maker Machine brings the refreshment to you, whether you're at home or in the office.



Mojito Machine

Equipment's

Hardware Equipment's

+ LCD 20x4

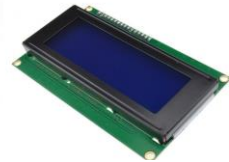

+ Keypad 4x4



+ Rotary Encoder

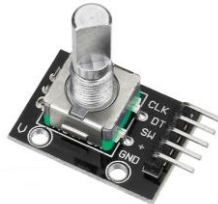

+ Green Leds & RGB Leds

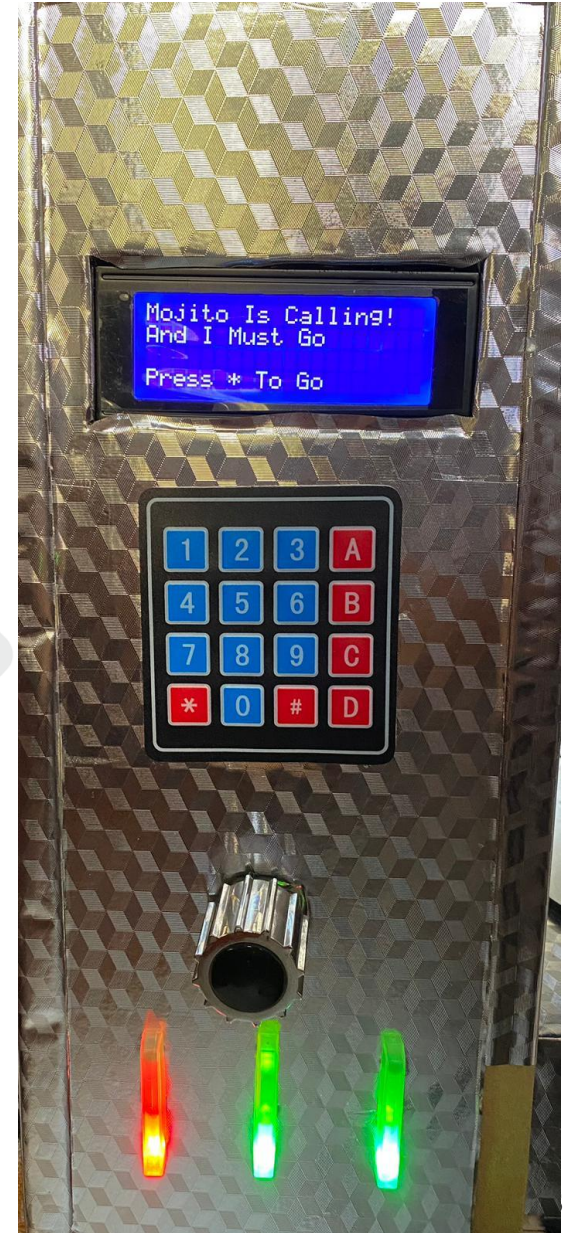
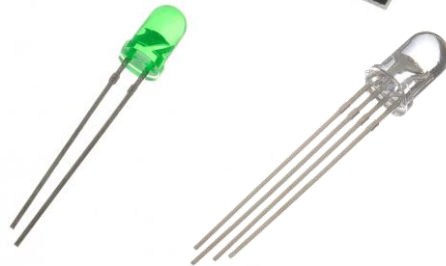

Hardware Equipment's

- + 2 MG966R Servo Motors



- + 3D Printed Cup Dispenser

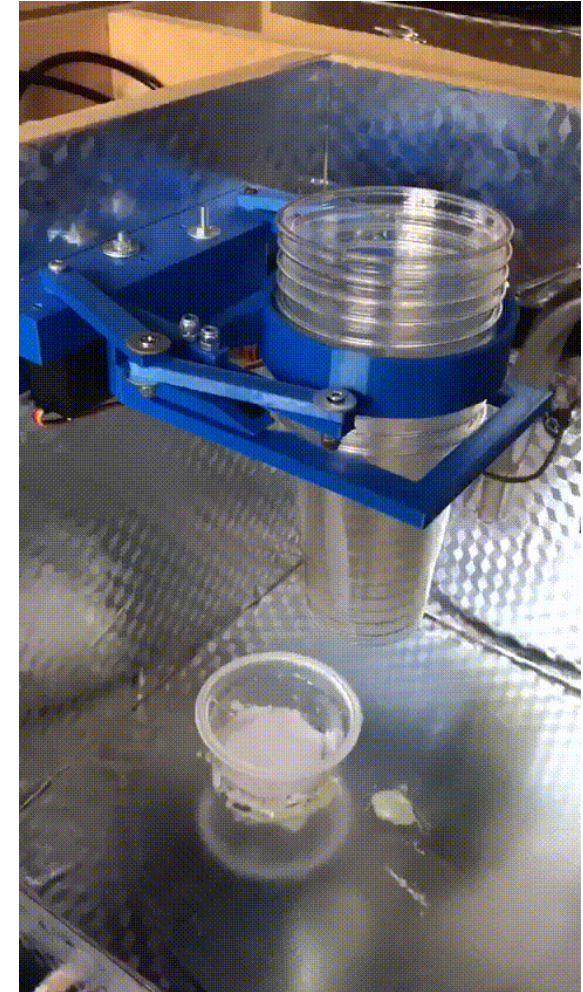
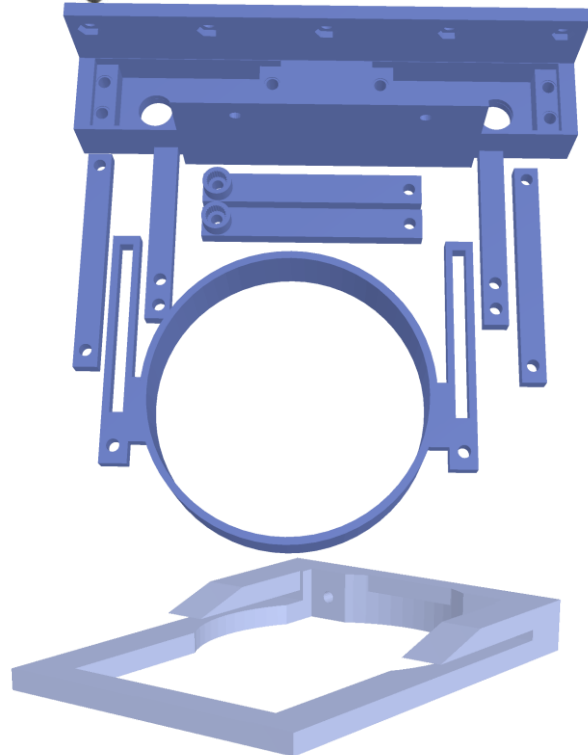

Hardware Equipment's

+ 1 MG966R Servo Motor

+ 3D Printed Straw Dispenser

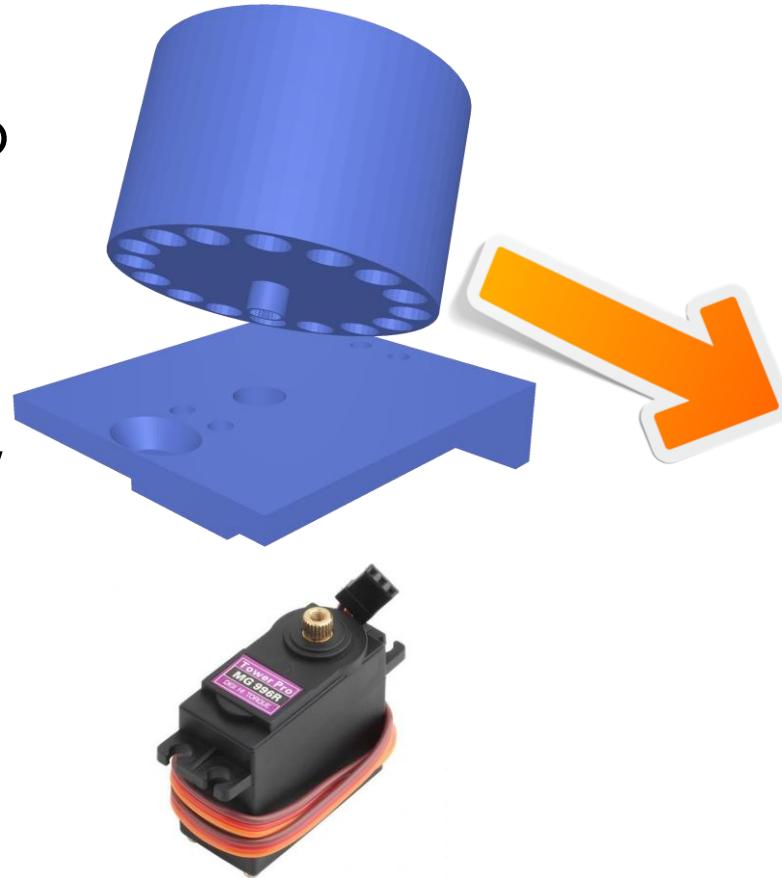

Hardware Equipment's

- + CNC designed plate
- + Nema 17 Stepper Motor
- + A4988 Stepper Driver

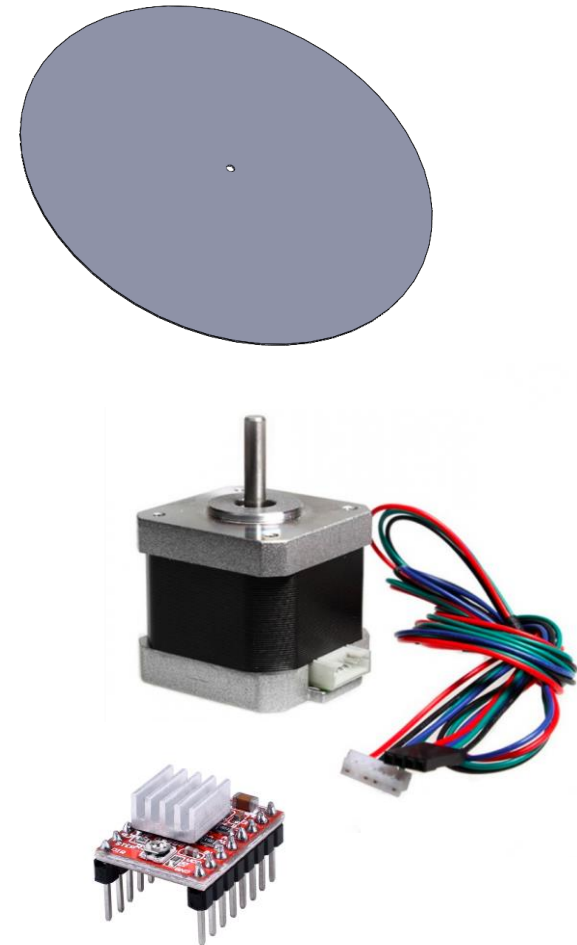

Hardware Equipment's

+ 12v DC Pumps



+ Water Pipe Tubes



+ 5v Relays



+ Ultrasonics



Hardware Equipment's

+ ESP8266 WiFi Module

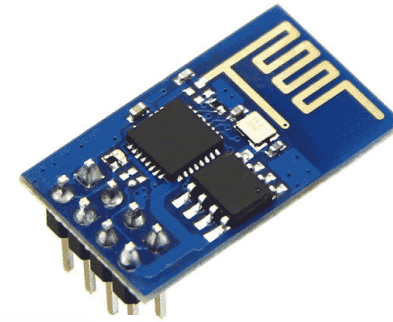

+ 12v Power Adapter



+ DC Voltage Regulator

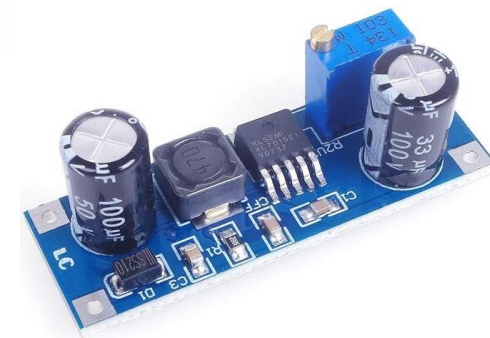

Machine Functionality



Functionality: Stage 1

- + Make your order
 - From Machine
 - From Mobile

Close Mojito Machine Stop

Home Page

Choose Mojito Flavor

- Strawberry Mojito
- Orange Mojito

Choose Flavor Mode

- Light Mode
- Heavy Mode

Save

Pure Mojito Mix Mojito

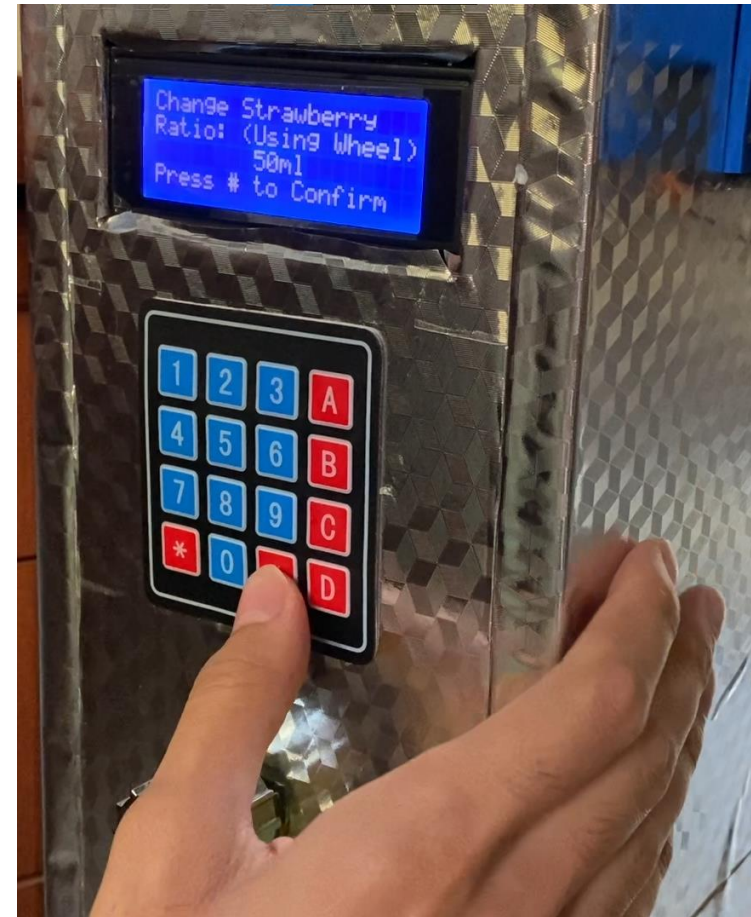

Functionality: Stage 2

- + Cup will be dropped
- + Plate will rotate 90 degrees

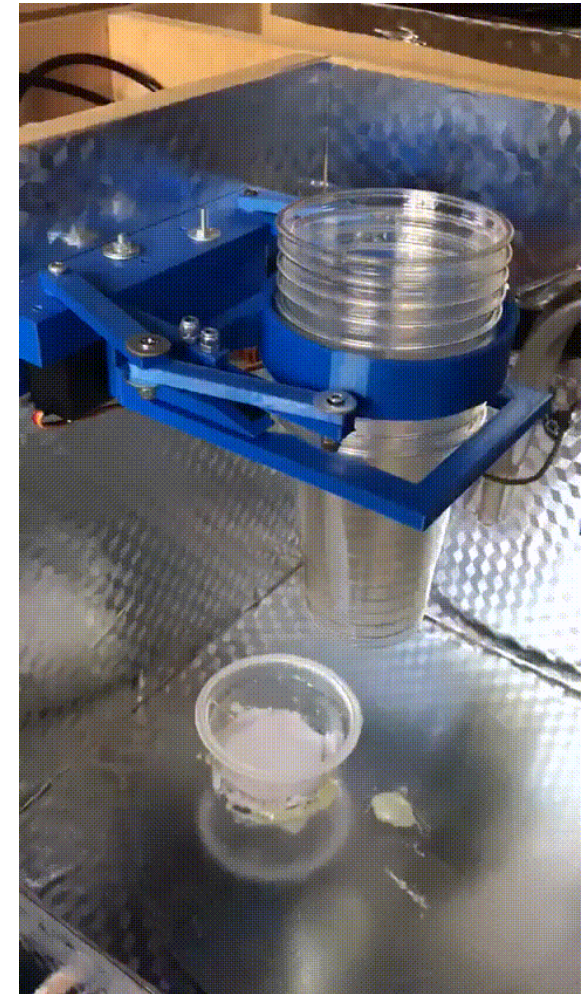

Functionality: Stage 3

- + Filling Flavors & Water
- + Plate will rotate 90 degrees

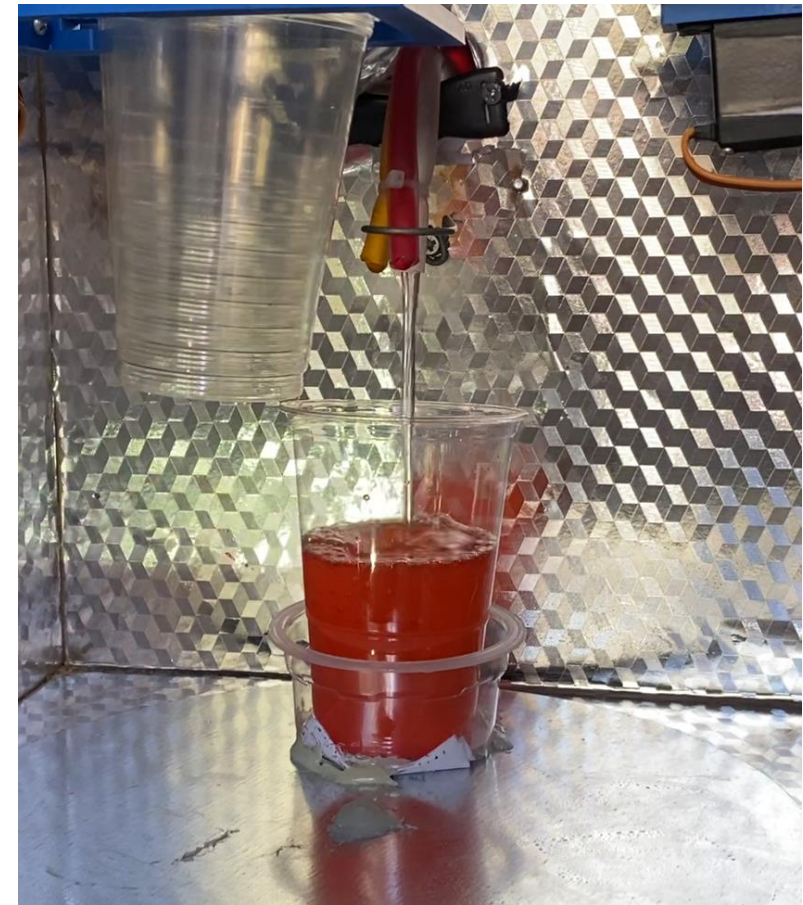

Functionality: Stage 4

- + Dropping Straw
- + Plate will rotate 90 degrees



Functionality: Stage 5

+ Enjoy Your Mojito!





Constraints

Constraints

Lack of Time

- + More Time, More Improvements

Lack of Funds

- + PCP design & print, costs a lot!
- + Better liquid pumps costs more
- + Touch Screen Costs more

Lack of 3D Printing Experience

- + We seek the help of our experienced friends from different specializations

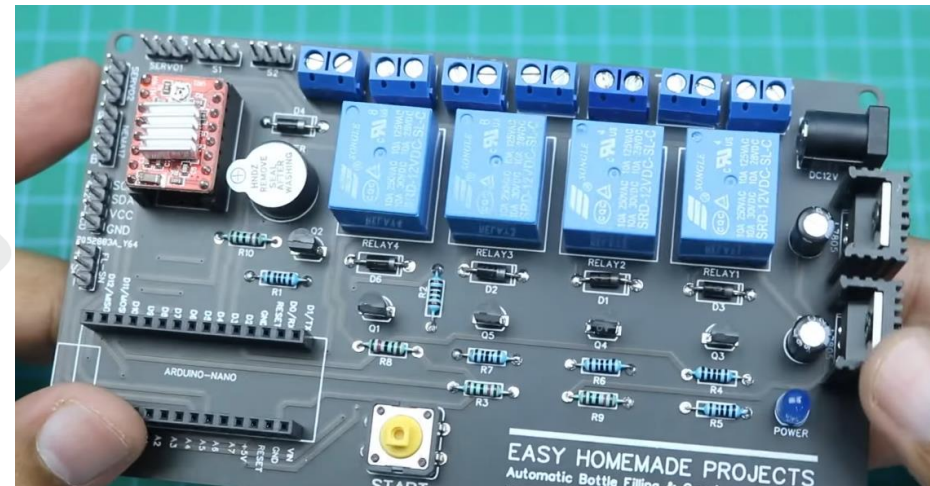
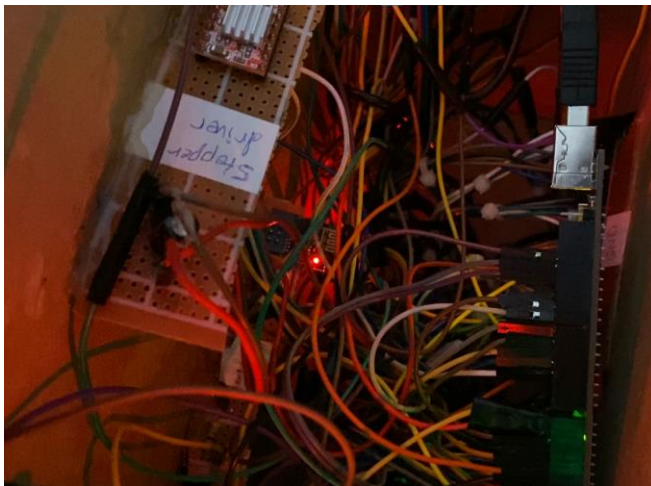



Future Work

- + Add more flavors
- + Put ice with Mojito
- + Add more cup sizes
- + Deliver the cup to user using small car robot



Thank you!



Any Questions?